

MISSION OVERVIEW

Understanding Mercury and how it formed is critical to better understanding the conditions on and evolution of the inner planets. Fortified against the searing conditions near the Sun, MESSENGER will provide the first images of the entire planet. The mission will also collect detailed information on the composition and structure of Mercury's crust, its geologic history, the nature of its thin atmosphere and active magnetosphere, and the makeup of its core and polar materials. On a 4.9-billion mile (7.9-billion kilometer) journey that includes 15 loops around the Sun, MESSENGER's

trajectory includes one pass at Earth, two by Venus, and three by Mercury, before easing into orbit around its target planet. The Earth flyby in August 2005, the first Venus flyby in October 2006, and the Venus 2 encounter in June 2007 used the pull of the planets' gravity to guide solar-powered MESSENGER toward Mercury's orbit. The Mercury flybys in January 2008, October 2008, and September 2009 fine-tune and slow MESSENGER's track while allowing the spacecraft to gather data critical to planning the mission's orbit phase.

TRAJECTORY PROFILE

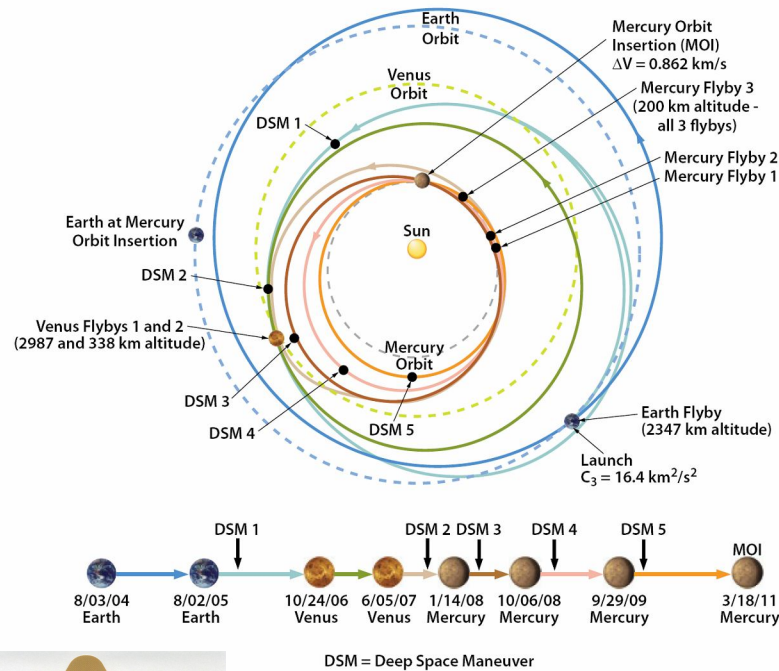

DSM = Deep Space Maneuver



SCIENCE PAYLOAD

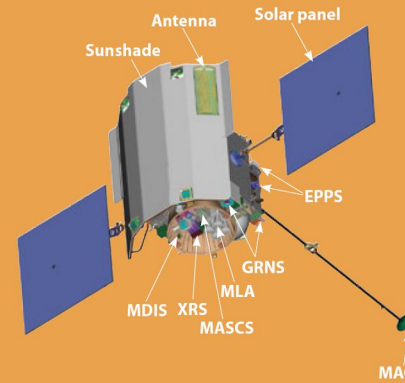

MESSENGER's science payload was carefully chosen to answer the mission's six key science questions. Most of the instruments are fixed rigidly to the spacecraft's body, so coverage of Mercury is obtained by spacecraft motion over the planet.

Those instruments are:

- **Mercury Dual Imaging System (MDIS)** – Applied Physics Laboratory
- **Gamma-Ray and Neutron Spectrometer (GRNS)** – Applied Physics Laboratory
- **X-Ray Spectrometer (XRS)** – Applied Physics Laboratory
- **Magnetometer (MAG)** – joint Applied Physics Laboratory and NASA's Goddard Space Flight Center
- **Mercury Laser Altimeter (MLA)** – Goddard Space Flight Center
- **Mercury Atmospheric and Surface Composition Spectrometer (MASCS)** – Laboratory for Atmospheric and Space Physics, University of Colorado at Boulder
- **Energetic Particle and Plasma Spectrometer (EPPS)** – joint Applied Physics Laboratory and University of Michigan
- **Radio Science (RS)** – Applied Physics Laboratory

07-0530R

MESSENGER

Mercury Surface, Space Environment, Geochemistry, and Ranging

The first
space mission
designed to
orbit the
planet closest
to the Sun



The Johns Hopkins University
APPLIED PHYSICS LABORATORY <http://messenger.jhuapl.edu>

1:24 scale

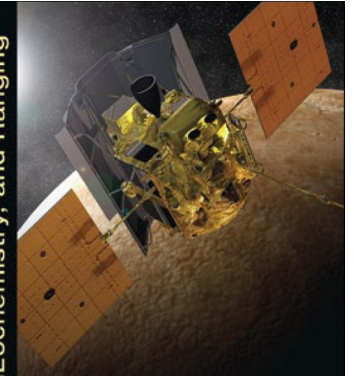

MESSENGER Mission to Mercury Spacecraft

- Print slides 1, 3, 4, 5, and 6 on card stock. Print this slide on plain paper. Slide 7 contains pictures and reference diagrams.
- Score all fold lines before cutting out parts.
- Cut out sun shade, fold and glue – carefully aligning the support arms on the front and back. Keep flat for now as the glue dries. Cut out, fold and glue the solar panels also. Keep flat.
- Cut out the main bus and fuel tank covers. Fold and glue into boxes. Glue the fuel tank covers in place on either side of the main bus aligned with the dotted lines. Note the outlines for tank #12 and the He tank to ensure correct placement.
- Cut out the thrust support ring and paint the back gray. Roll and glue into a flared circle, printed side out. Glue the narrower end to the bottom of the main bus aligned with the circle surrounding the outlines for parts #7, 8 and 9.
- Cut out the thruster nozzle (#13) and paint the back black. Roll into a cone and glue. Glue the nozzle to the top of the bus assembly as indicated by the numbered outline.
- Cut out the thrust shields, fold and glue. Fold the tabs and glue in place on either side of the thruster nozzle, aligned with the purple markings, and with the tabs inward (toward the thruster nozzle).
- Cut out the He tank, fuel tanks (#14) and part #12. For each assembly, roll and glue the cylinder, fold the end tabs inward, and glue on the end cap(s). Glue each to the bus assembly as indicated by the numbered or labeled outlines.
- Cut out the battery, fold and glue into a box. Glue to the top of the bus assembly as indicated.
- Cut out the star trackers and paint the back of the rectangles black. Roll and glue into cylinders. Fold and glue the base boxes, then glue the cylinders to the blue circles. Glue the star trackers to the top of the bus assembly on the spots marked “S.”
- Glue the momentum wheels and mounts to thick (several layers) card stock. Cut out and glue the disks to the mounts, then glue to the bus assembly on the sun shade side in the indicated positions.
- Cut out Ant 2 and the remaining numbered instruments. Fold and glue into boxes. Glue each to the bus assembly in its marked position. Refer to the spacecraft diagrams for details.
 - Parts 5 and 15 have attached cylinders. Roll and glue the rectangles into narrow cylinders and attach to the larger blue circles on the instruments.
 - Part 10 consists of four cylinders glued inside the thrust support ring over the four circles printed there. Roll and glue one long, narrow cylinder, then cut it into four equal parts. Glue each cylinder in place aligned in a square.
 - Part 8 has optional detail – if not used simply cut off the three small squares on the left side of the pattern and assemble the remainder into a box.
- Keep the center section of the sun shade flat, curl the edges toward the back (gray) side - outboard of the line joining the green squares. Keep the struts straight. Glue the bus assembly (marked “to sun shade”) to the sun shade, centered in the dotted square on the gray side. The “ears” go on the top (top is the end of the bus with the thruster nozzle). Carefully bend the struts inward to meet the bus assembly (black dots) and glue in place. Adjust the curl of the shade’s edges as needed.
- Cut a narrow dowel to the lengths needed for the solar cell mount and MAG boom. Split both ends of the dowel for the solar cell assembly. Carefully drill out the 3 small blue circles on the sides and back of the bus assembly. Insert the dowel for the solar cells through the sides of the bus. Slip the solar arrays into the split ends of the dowel and secure (folded edge of each array – with red line – attaches to the mount).
- Cut out the parts for the MAG instrument. Roll and glue the rectangle into a narrow cylinder. Glue the disk to the end of the MAG boom, glue the cylinder to the center of the disk. Insert the MAG boom into the hole you drilled in the back of the bus for the previous step and glue in place.
- Cut out the base graphic (page 1) and glue to a flat board. Drill a hole for a small dowel, positioned as desired. Split one end of the dowel and secure the model by wedging the edge of the sun shade into the split.
- Use printer settings to adjust printout size for smaller scales.

MESSENGER Mission to Mercury Spacecraft 1:24 Scale

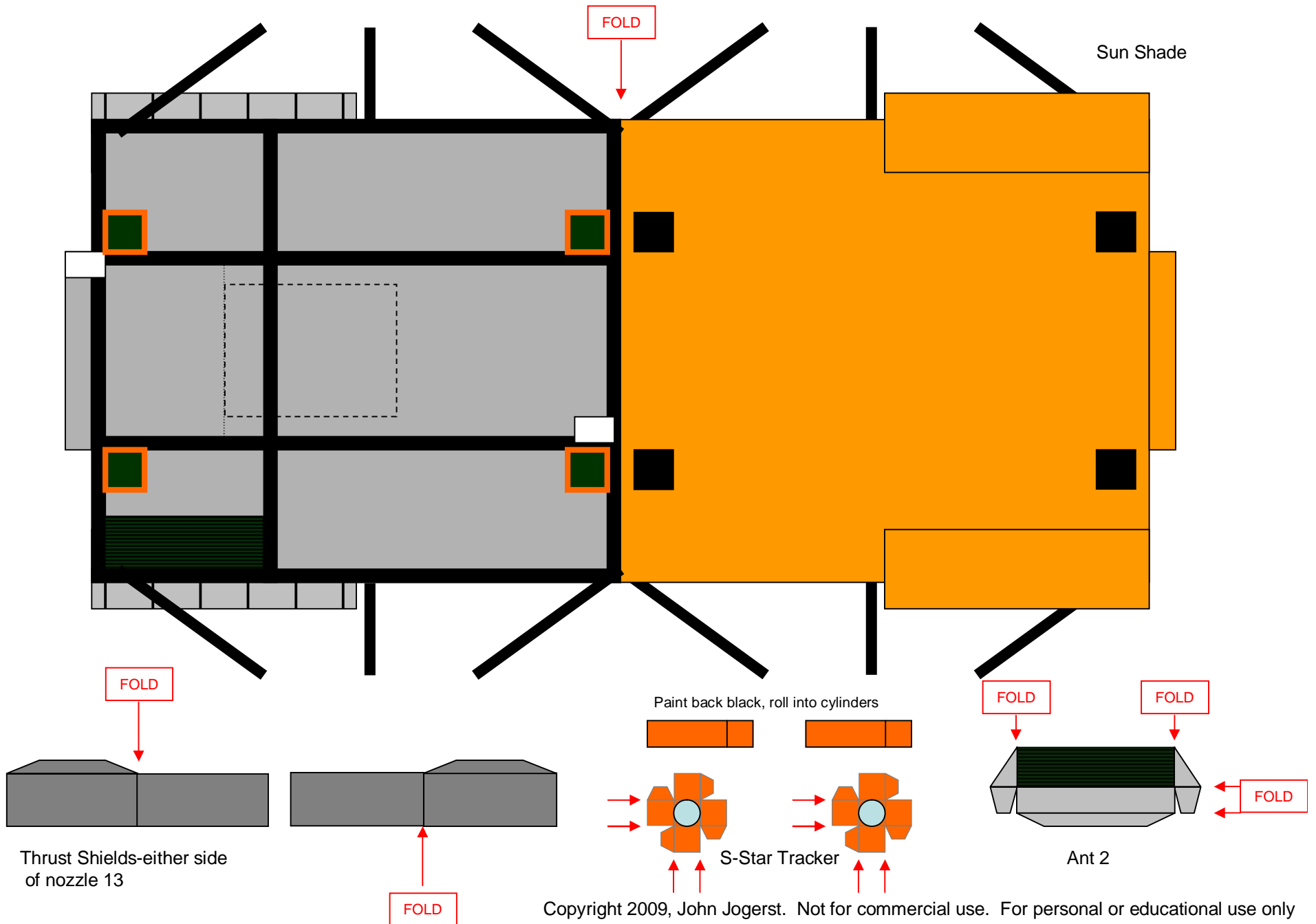

MESSENGER Mission to Mercury Spacecraft 1:24 Scale

Solar arrays

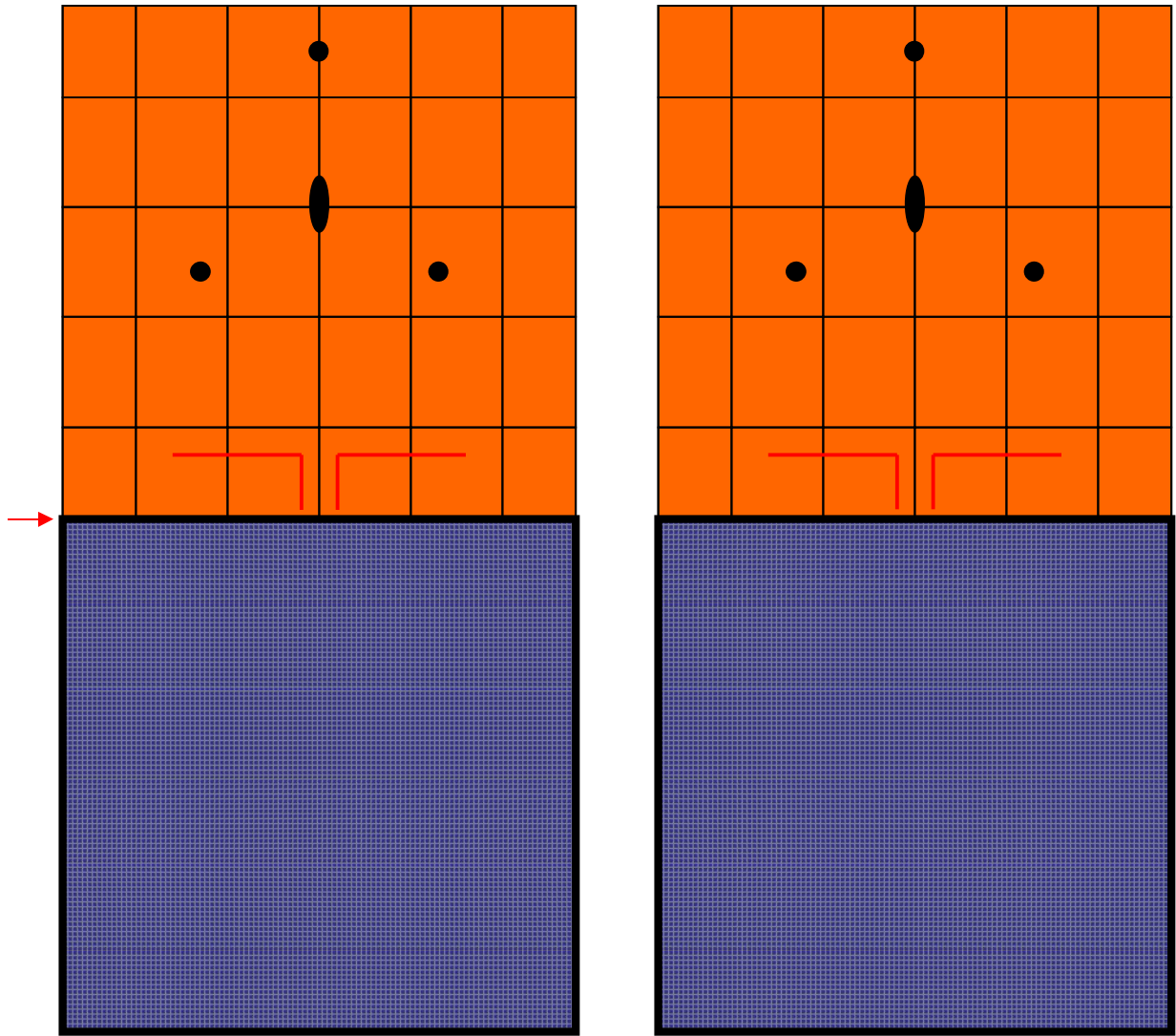

Battery

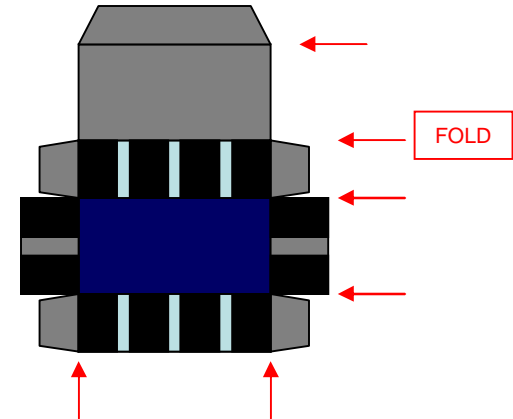

He Tank

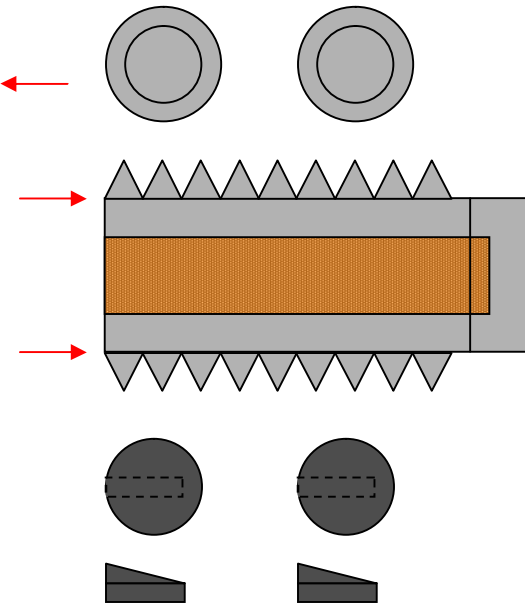

MW – Momentum Wheel
 Glue to thick cardstock and
 attach to bus (sunshade side)
 as indicated

MESSENGER Mission to Mercury Spacecraft 1:24 Scale

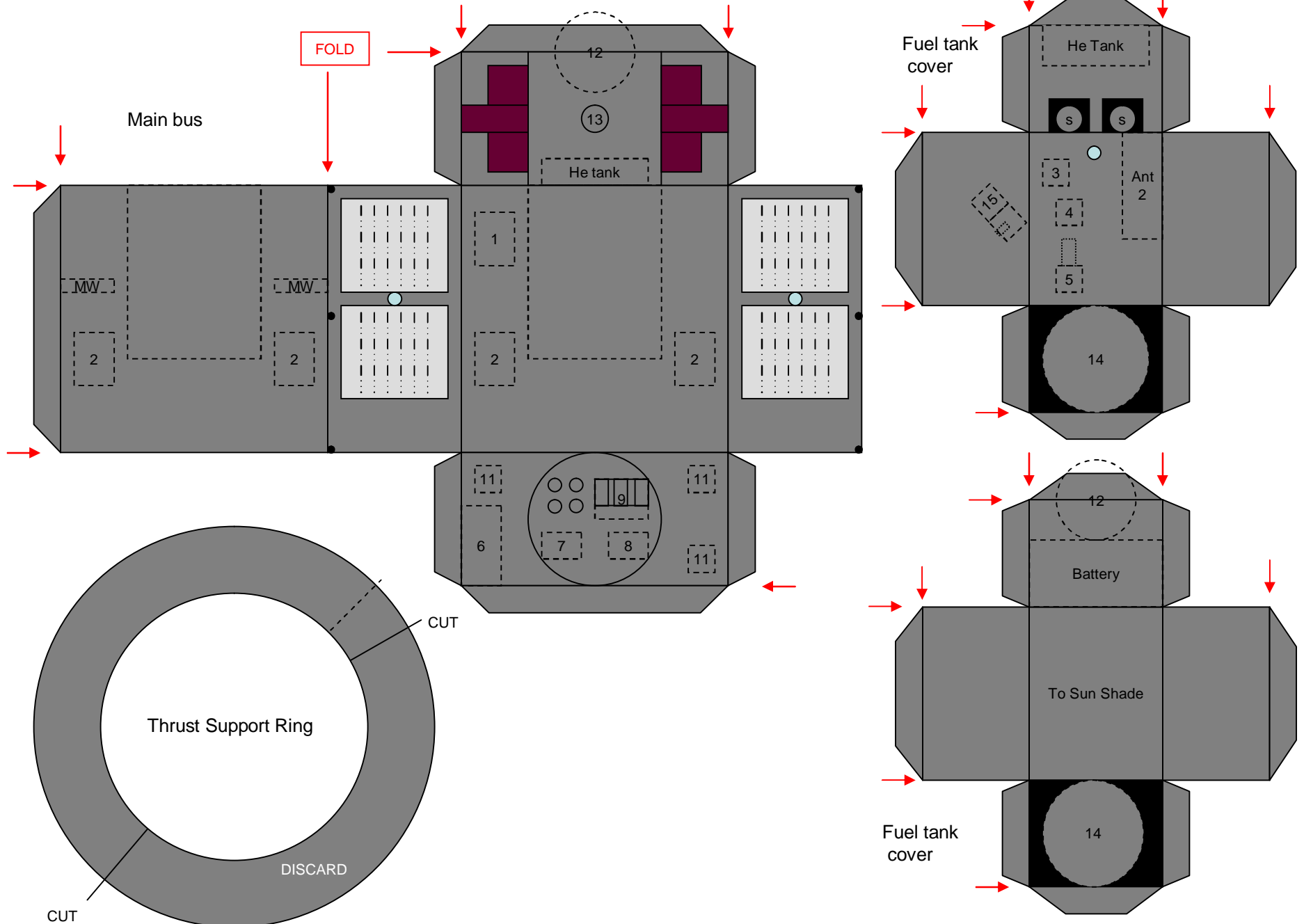

MESSENGER Mission to Mercury Spacecraft 1:24 Scale

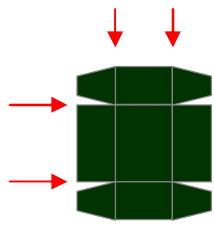

1

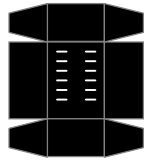

2

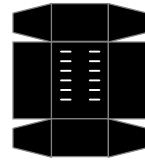
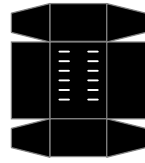
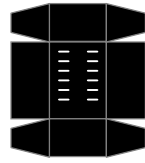

FOLD

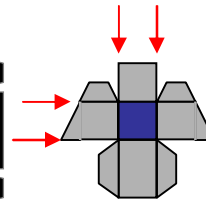

3 EPPS/
EPS

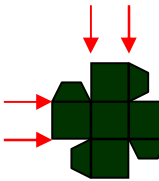

4

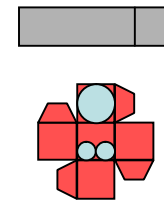

5 GRNS

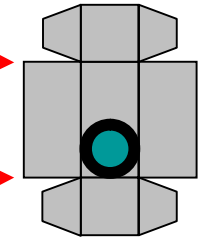

6

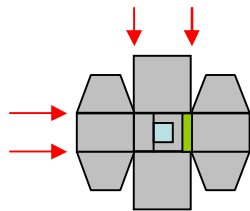

MASCS

7

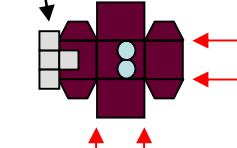
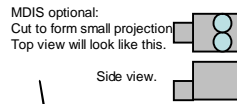

MDIS

8

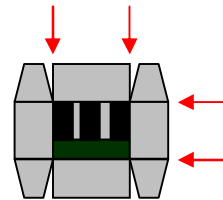

XRS

9

Roll, then cut into
four parts on red lines

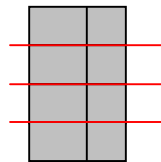

MLA

10



DPU

11

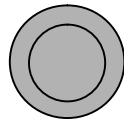
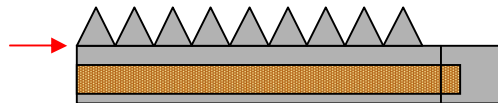

12

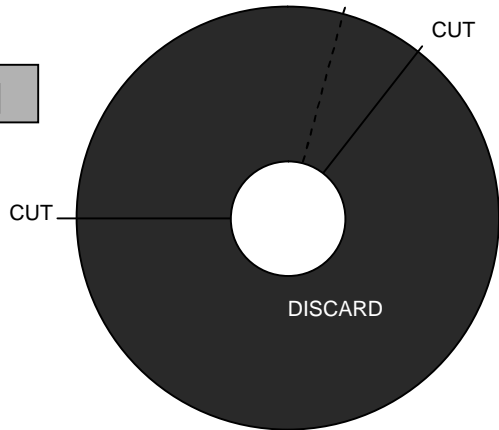

13 THRUSTER
NOZZLE

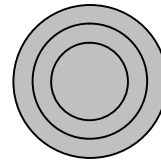
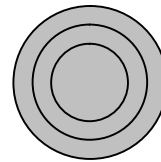

14

FUEL TANKS

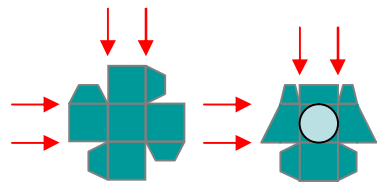

15 EPPS/FIPS

LENGTH FOR MAG BOOM – use thin dowel

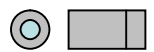

MAG: glue circle to end of boom, roll cylinder and attach to center of circle.

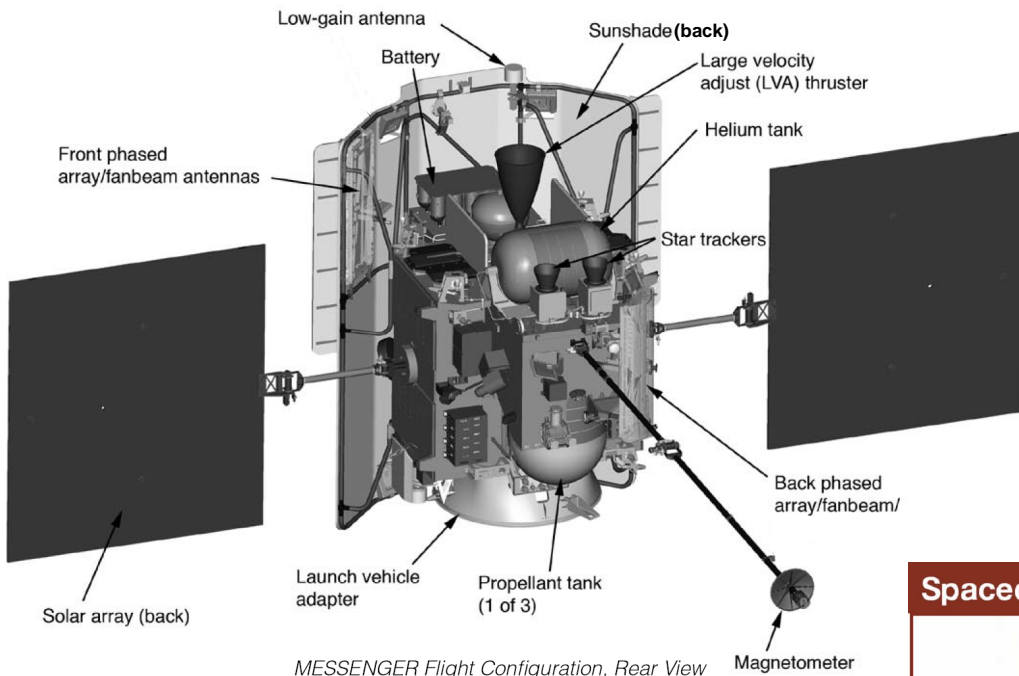

MESSENGER Flight Configuration, Rear View

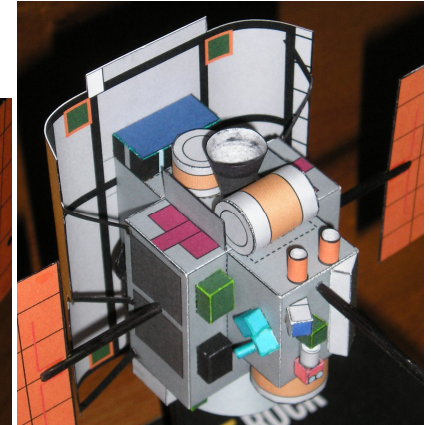
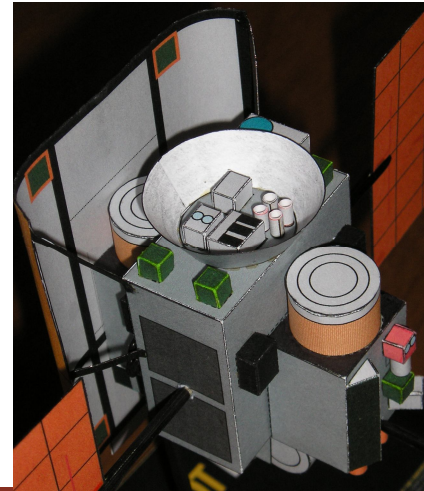

Spacecraft Instruments

